

Richter Lined Standard ASME and ISO Ball Valves

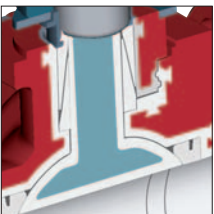
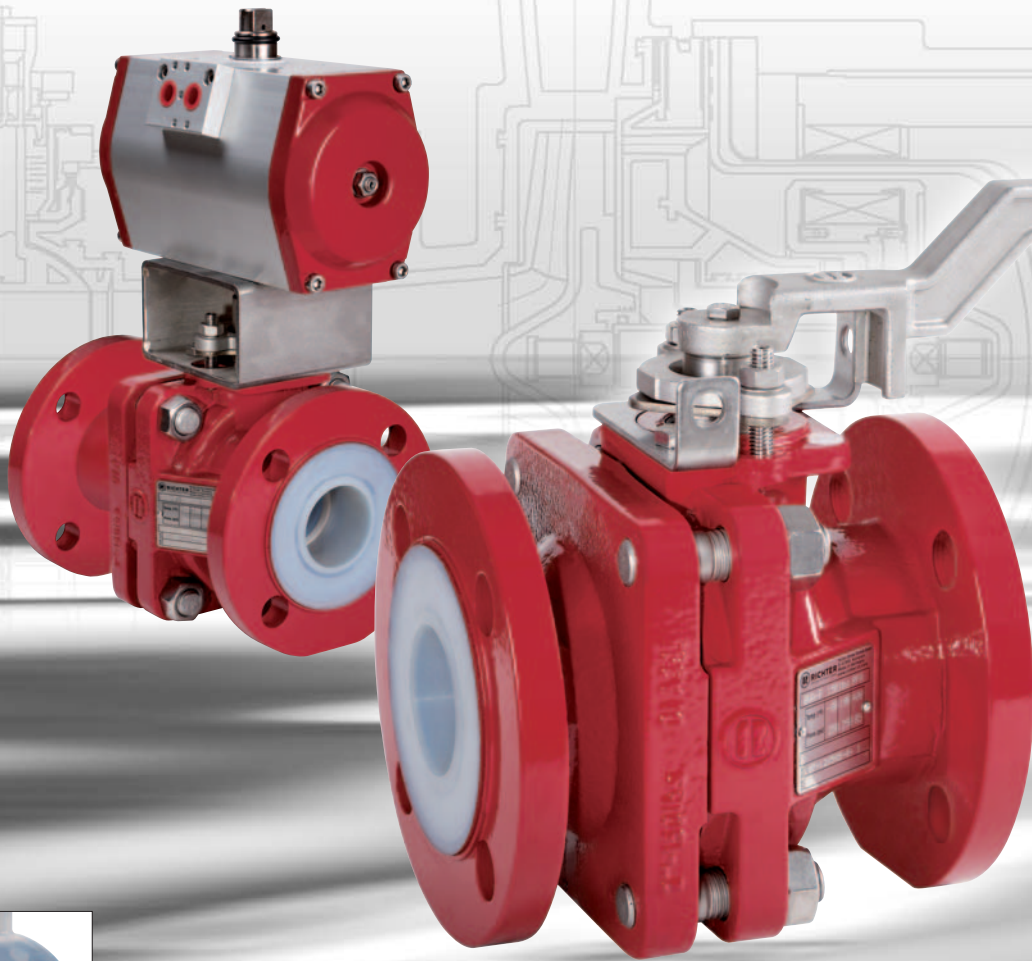

- Lining virgin PFA
- One-piece ball/stem design, Al_2O_3 ball option
- Maintenance-free stem seal
- Low torque, high flow rate

Lined Standard ASME/ANSI and ISO/DIN Ball Valves

Fields of application

The design of the ball valves series BVA and BVI is based on more than 30 years of application experience with lined ball valves. They provide an excellent ratio of economic and operational performance in a wide variety of process applications.

The Richter ball valves BVA and BVI are designed

- as shut-off and automated valves for corrosive and hazardous media,
- where stainless steel, special metals, PVDF etc. are not sufficiently corrosion-resistant,
- as alternative to valves made of exotic special metals and
- serve as reliable alternative to lined plug valves due to higher flow rates, much lower torques and minimum maintenance.

Product features

- PFA-lined one-piece ball/stem unit, optional Al₂O₃ ceramic ball
- Full ports of BVA sizes 1", 1.5" and 2" to ASME/ANSI as well as BVI DN 25 through DN 150 to ISO result in high flow rates, minimum pressure losses and a more efficient piping system.
- BVA sizes 3", 4" and 6" to ASME/ANSI with reduced port feature a compact design with smaller valve body envelope and lowest possible torque for economic actuation.
- Various product options, e.g. locking devices and gear operators

Type code	manual actuation	remote actuation
• ASME/ANSI ball valve	BVA/...	BVAP/...
• ISO/DIN ball valve	BVI/...	BVIP/...
• Lining PFA fluoroplastic		.../F

Efficient alternative to plug valves

- Plug valves provide some 2/3 of full port ball valve flow only, whereas full port ball valves allow for downsizing of pipeline system by at least 1 size. Reduced port ball valves provide flows equal to plug valves.
- Plug valves require 100-350% more torque, therefore in most cases larger actuator needed.
- The plug is seated in the body lining instead of seat rings. Wear and tear requires body or complete valve ("throw away valve") to be exchanged. No ceramic option.
- Plug valves have conventional packing-type stem sealing, not self-adjusting, not maintenance-free.
- Cavity volume underneath plug
- Plug core usually made of ductile iron unlike ball valves with SS ball core

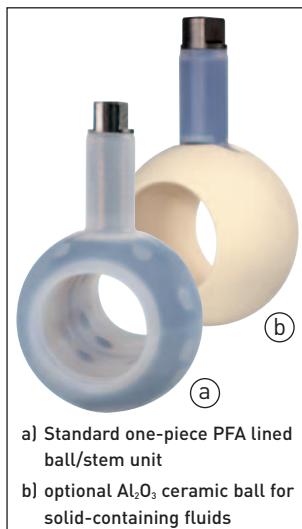

Reliable body and seat sealing

- ① **3 mm (1/8") thick virgin PFA body lining**
 - High permeation resistance
 - Vacuum-proof anchored
 - Translucent, optimum quality assurance
- ② **Pressure-bearing body made of ductile cast iron EN-JS 1049 (0.7043)/ASTM A395, absorbs system and pipe forces.**
- ③ **Permanent body flange sealing**
 - Effective even under the most frequent thermal cycle conditions
 - Sealing zone (3a) with **full lining thickness**
 - **Labyrinth-like sealing (3b)** maximizes surface pressure.
 - **Body pieces position themselves properly** by means of the cup and cone shapes (3c) of each piece. **Metal centering (3d)** with-stands lateral and angular pipe forces.
 - **Almost metal-to-metal flange contact (3e)** in the circumference area controls the effects of temperature variations.

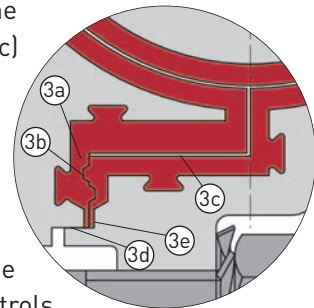

- ④ **One-piece ball/stem design**
 - Stainless steel core
 - Eliminates individual plastic lined mating parts for higher pressure/temperature ratings and optimises operational safety.
 - Al₂O₃ (99,7%) ceramic ball option
- ⑤ **Energised PTFE seat rings** provide a permanent spring load onto the ball and ensure of gas-tight sealing.
- ⑥ **Time-tested maintenance-free stem seal**
 - Outstanding long-life seal performance
 - Gas-tight to EN 12266, leakage rate A
 - Spring gland follower ensures of tightness even with changing conditions.
 - Visual inspection of sealing load
 - Manually adjustable from outside
- ⑦ **Universal ISO 5211 mounting dimensions**
- ⑧ **External corrosion protection**
Body epoxy coated. Packing gland, lever, lever stop, nuts and bolts stainless steel. Optional ASTM A193/B7M bolting.

Innovative cone shape stem seal design

The PTFE packing insert translates a low axial thrust into a higher radial sealing force by means of the law of cone. The packing gland is designed with a diameter as small as possible. The result: outstanding stem seal performance under the most challenging conditions, permanent preload controlled manual adjustability at any time.

An added benefit is the ability to monitor the live loaded condition of the stem seal simply by inspecting the "gap" between the packing followers, thus lending this design to the user's preventive maintenance program.

Stem seal design

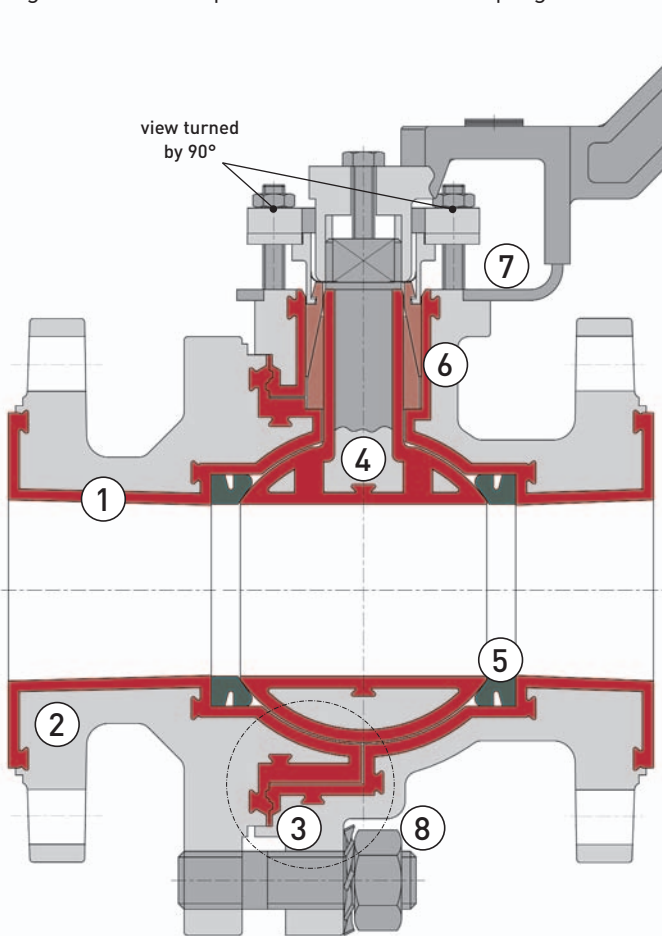
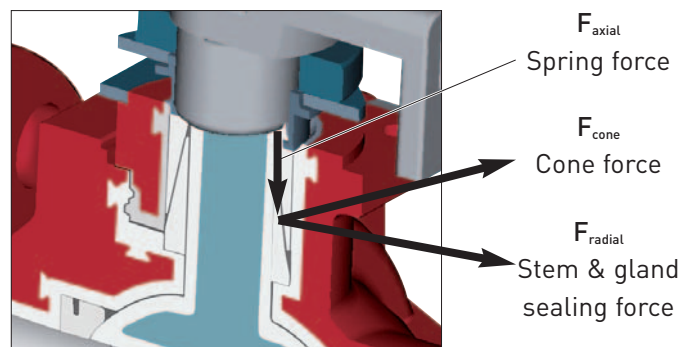

Pressure/temperature range

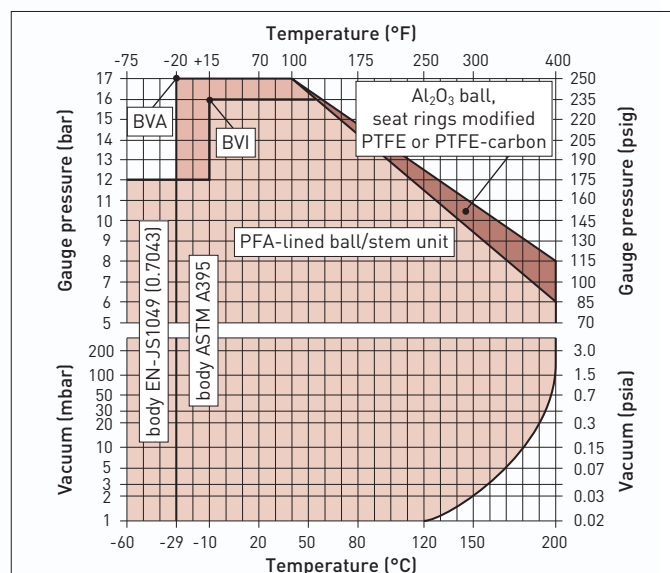

Body EN-JS1049 (0.7043)/PFA:

-60 °C [-75 °F] to +200 °C (400 °F);
max. 16 bar (235 psi) acc. to AD 2000

Body ASTM A395/PFA:

-29 °C [-20 °F] to +200 °C (400 °F);
max. 17.2 bar (250 psi) acc. to ASME B16.42

For low temperature applications observe local rules!

A special material is used for the metal core of the ball/stem in case of operating temperatures below -10 °C (15 °F).

Flow rates

Valve size		K_v (m ³ /h)	C_v (US gpm)
BVI (mm)	BVA (inch)		
DN 25	1"	60	70
DN 40	1 1/2"	190	221
DN 50	2" & 3"	280	326
DN 80	4"	587	684
DN 100	6"	1250	1456
DN 150	-	2800	3262

conversion:

$$C_v = k_{v100} \cdot 1,165 \text{ (US gpm)}$$

$$k_{v100} \cdot 0,971 \text{ (Imp. gpm)}$$

Operating torques PFA-lined ball/stem unit

Δp bar (psi)									
3 (45)		6 (85)		10 (145)		17.2 (250)		max. adm.	
Nm	in-lbs	Nm	in-lbs	Nm	in-lbs	Nm	in-lbs	Nm	in-lbs
8	71	8	71	8	71	10	89	70	620
15	133	15	133	15	133	20	177	225	1990
20	177	20	177	20	177	25	221	225	1990
50	443	50	443	62	549	83	735	500	4425
80	708	80	708	92	814	120	1062	500	4425
200	1770	230	2036	270	2390	315	2788	2200	19470

Torques measured with water 20 °C (68 °F). Depending on the medium, e.g. gases or viscous resp. crystallizing liquids, the torques could increase.

Operating torques Al₂O₃ ceramic ball

Δp psi (bar)									
3 (45)		6 (85)		10 (145)		17.2 (250)		max. adm.	
Nm	in-lbs	Nm	in-lbs	Nm	in-lbs	Nm	in-lbs	Nm	in-lbs
10	89	10	89	10	89	12	106	32	283
20	177	20	177	20	177	25	221	80	708
25	221	25	221	25	221	30	266	120	1062
60	531	60	531	72	637	95	841	250	2215
90	797	130	1151	150	1328	200	1770	350	3098
350	3098	400	3540	580	5133	770	6815	1200	10620

Dimensions and weights BVA (ASME/ANSI):

face to face ASME/ANSI B16.10 short, flanges ASME (ANSI) B16.5 Cl. 150 ****

BVA	ØPort		L		HL		H		D		k		nxd ₁		EN ISO 5211	H1		H5		H2		Weight** approx.		
	DN	inch	mm	inch	mm	inch	mm	inch	mm	inch	mm	inch	mm	inch		mm	inch	mm	inch	mm	inch	kg	lbs	
25	1"	24.5	0.964	127	5.0	179	7.05	130	5.12	108	4.25	79.5	3.125	4x16	4x ⁵ / ₈	F05	50	1.97	60	2.36	60	2.36	5	11
40	1½"	38	1.496	165	6.5	260	10.24	155	6.1	127	5.0	98.5	3.875	4x16	4x ⁵ / ₈	F07	77	3.03	94	3.70	60	2.36	10.8	24
50	2"	47.5	1.87	178	7.0	260	10.24	155	6.1	152.5	6.0	120.5	4.75	4x19	4x ³ / ₄	F07	80	3.15	97	3.82	60	2.36	13	28.5
80	3"	47.5	1.87	203	8.0	260	10.24	155	6.1	190.5	7.5	152.5	6.0	4x19	4x ³ / ₄	F07	80	3.15	97	3.82	60	2.36	17	37.5
100	4"	78	3.07	229	9.0	313	12.32	180	7.09	229	9.0	190.5	7.5	8x19	8x ³ / ₄	F10	118	4.64	140	5.51	80	3.15	36	79
150	6"	96	3.78	267	10.5	313	12.32	195	7.68	279.5	11.0	241.5	9.5	8x22.5	8x ⁷ / ₈	F10	134	5.27	156	6.14	80	3.15	53	117

Dimensions and weights BVI (ISO/DIN):

face to face ISO 5752-Series 1 (DIN 3202 F1), flanges ISO 7005-2 ***

BVI	ØPort		L		HL		H		D		k		nxd ₁		EN ISO 5211	H1		H5		H2		Weight** approx.		
	DN	inch	mm	inch	mm	inch	mm	inch	mm	inch	mm	inch	mm	inch		mm	inch	mm	inch	mm	inch	kg	lbs	
25	1"	24.5	0.964	160	6.3	179	7.05	130	5.12	115	4.52	85	3.35	4x14	4x0.55	F05	50	1.97	60	2.36	60	2.36	5.5	12
40	1½"	38	1.496	200	7.87	260	10.24	155	6.1	150	5.9	110	4.33	4x18	4x0.71	F07	77	3.03	94	3.70	60	2.36	12	26
50	2"	47.5	1.87	230	9.05	260	10.24	155	6.1	165	6.5	125	4.92	4x18	4x0.71	F07	80	3.15	97	3.82	60	2.36	14	31
80	3"	78	3.07	310	12.2	313	12.32	180	7.09	200	7.87	160	6.3	8x18	8x0.71	F10	118	4.64	140	5.51	80	3.15	30	66
100	4"	96	3.78	350	13.78	313	12.32	195	7.68	220	8.66	180	7.09	8x18	8x0.71	F10	134	5.27	156	6.14	80	3.15	46	102
150	6"	145	5.71	480	18.9	515*	20.27*	265	10.43	285	11.22	240	9.45	8x22	8x0.87	F12	184	7.24	215	8.46	100	3.94	86	190

* BVI size 150 mm (6"): with Δp > approx. 2 bar (29 psi) a worm gear is recommended instead of hand lever. Details on request.

** manually operated, PFA lined ball/stem unit

*** on request drilled to ASME (ANSI) B16.5 Cl. 150, JIS 10K

**** on request drilled to JIS 10K, ISO 7005-2

Components and materials

Item	Designation	Material
101	Main body	Ductile iron ASTM A395/EN-JS1049; PFA lined
102	Body end piece	Ductile iron ASTM A395/EN-JS1049; PFA lined
200	Ball	Al ₂ O ₃
201	Ball/stem unit	Stainless steel, PFA lined
202	Stem	Stainless steel, PFA lined
203	Lever	Stainless steel
401	Seat rings	PTFE ¹⁾
405/1	Thrust ring	Stainless steel
422	Base ring	Modified PTFE
423	Packing insert	PTFE
502	Spring gland follower	Stainless steel
503	Packing gland follower	Stainless steel
510	Bracket	Stainless steel
557	Grounding spring washer	Stainless steel
577	Lever stop	Stainless steel
804	Coupling	Stainless steel
850	Actuator	Customer to specify
w/o No.	Screws and nuts	Stainless steel

¹⁾ Modified PTFE seat rings supplied with Al₂O₃ ceramic ball

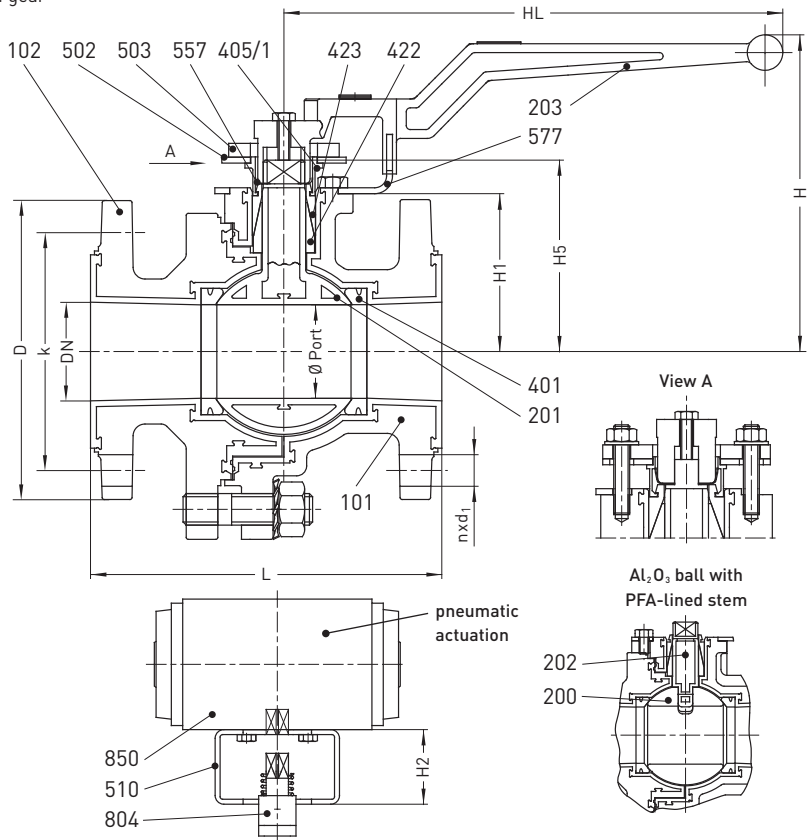

Presented by:

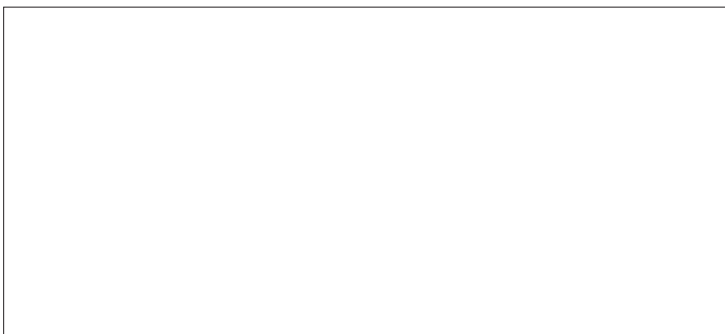

RICHTER

Process Pumps & Valves

Richter Chemie-Technik GmbH
 Otto-Schott-Str. 2
 D-47906 Kempen, Germany
 Tel. +49 (0) 21 52/146-0
 Fax +49 (0) 21 52/146-190
 richter-info@richter-ct.com
 www.richter-ct.com